

# Panel mounted inlet

Part number: 837

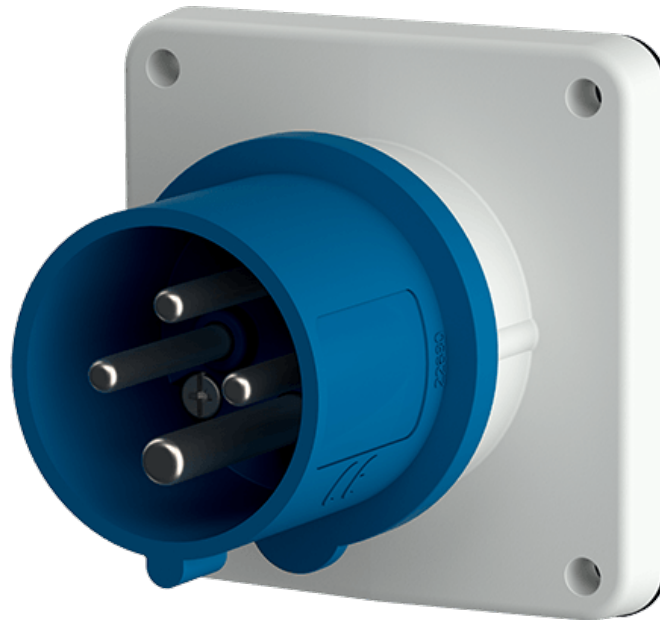

**MENNEKES**  
Elektrotechnik GmbH & Co. KG

Aloys-Mennekes-Straße 1  
57399 Kirchhundem  
GERMANY

# Product Description

- screw connection technology
- nickel plated contacts
- external fixing
- a retaining nose to hold the hinged lid of the connector must be provided by the customer in order to ensure satisfactory locking

# Technical Details

Panel mounted inlet	837
Ampere	16A
Number of poles	4p
Clock position	9h
Nominal voltage AC	230V
Nominal frequency	50 - 60 Hz
Protection type IP	IP44
Contact carrier	nickel plated contacts
Connection	screw terminals
Tightening torque connection terminal	PZ2, slot
Phase inverter	without phase inverter
Pilot contact	without pilot contact
Flange dimensions	85.7 x 85.7 mm
Hole spacings	69.5 x 69.5 mm
Insertion direction	straight
Type of mounting	external fixing
Military version	no
Protection cap	without protection cap
Tightening torque connection terminal for cable cross-section 1,0 - 1,5 mm <sup>2</sup>	0.6 Nm
Tightening torque connection terminal for cable cross-section 2,5 - 4,0 mm <sup>2</sup>	0.8 Nm
Recommended wire end treatment for supply cable connection terminal	ferrule square gasproof crimped
Strip length conductor	8 - 10 mm
Conductor cross-section min.	1.5 mm <sup>2</sup>
Conductor cross-section max.	4 mm <sup>2</sup>

Panel mounted inlet	837
Weight (net)	157 g
Packaging unit	10 Stück
Quantity per pallet	880 Stück
EAN / identification number	4015394117124

Permissible ambient conditions

	Min.	Max.
Permanent ambient temperature	-25 °C	40 °C
Average temperature over 24 hours		35 °C

Material properties

Front part	PA6 blue [similar RAL 5007]
Flange	PC light grey [similar RAL 7035]

Material resistance

The material resistance overview can be found on the website in the section “Knowledge” - “Product knowledge” - “Materials”.

Material and environmental properties

RoHS 2011/65/EU incl. 2015/863/EU	✓
POP regulation (EU) 2019/1021	✓

Regulations and Standards

Norm	DIN EN IEC 60309-2
Declaration of Conformity	CE
Test label	VDE (ÜG), EAC, CQC

# Dimensional Drawing

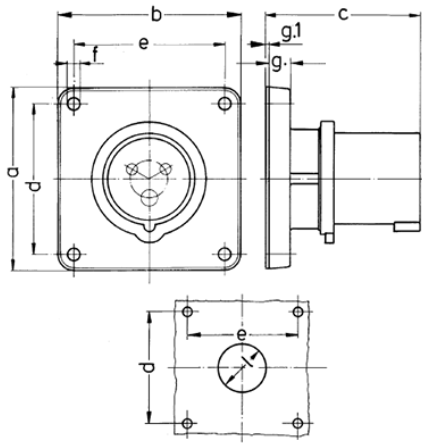

Drawing	Amp. Poles	16			32		
		3	4	5	3	4	5
2 MB 173/2							
Dim. in mm	a	85.7	85.7	85.7	85.7	85.7	85.7
	b	85.7	85.7	85.7	85.7	85.7	85.7
	c	72	72	72	90	90	90
	d	69.5	69.5	69.5	69.5	69.5	69.5
	e	69.5	69.5	69.5	69.5	69.5	69.5
	f	5.5	5.5	5.5	5.5	5.5	5.5
	g.	11	11	11	11	11	11
	g.1	2	2	2	2	2	2
	l	32	36	36	47	47	47
	Terminal for cond. cross section (mm <sup>2</sup> ) min.-max.	1.5	1.5	1.5	2.5	2.5	2.5
		-4	-4	-4	-10	-10	-10