

Panel mounted inlet

Part number: 3658

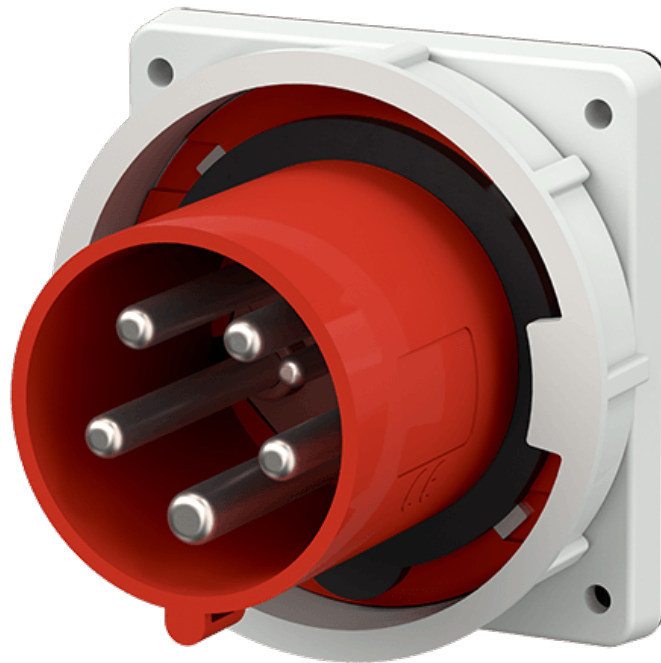

MENNEKES
Elektrotechnik GmbH & Co. KG

Aloys-Mennekes-Straße 1
57399 Kirchhundem
GERMANY

Product Description

- highly heat resistant contact carrier, nickel plated contacts
- frame terminals
- external fixing
- a retaining nose to hold the hinged lid of the connector must be provided by the customer in order to ensure satisfactory locking

Technical Details

Panel mounted inlet	3658
Ampere	63A
Number of poles	5p
Clock position	6h
Nominal voltage AC	400V
Nominal frequency	50 - 60 Hz
Protection type IP	IP67
Contact carrier	highly heat resistant contact carrier, nickel plated contacts
Connection	frame terminals
Tightening torque connection terminal	PZ2, slot
Phase inverter	without phase inverter
Pilot contact	1 pilot contact
Flange dimensions	110 x 106 mm
Hole spacings	90 x 90 mm
Insertion direction	straight
Type of mounting	external fixing
Military version	no
Protection cap	without protection cap
Tightening torque connection terminal	2 Nm
Recommended wire end treatment for supply cable connection terminal	usable with and without ferrule
Strip length conductor	18 mm
Conductor cross-section min.	6 mm ²
Conductor cross-section max.	16 mm ²
Weight (net)	590 g

Panel mounted inlet	3658
Packaging unit	5 Stück
Quantity per pallet	440 Stück
EAN / identification number	4015394020462

Permissible ambient conditions

	Min.	Max.
Permanent ambient temperature	-25 °C	40 °C
Average temperature over 24 hours		35 °C

Material properties

Front part	PC red [similar RAL 3013]
Flange	PC light grey [similar RAL 7035]
Bayonet ring	PC/PET light grey [similar RAL 7035]

Material resistance

The material resistance overview can be found on the website in the section “Knowledge” - “Product knowledge” - “Materials”.

Material and environmental properties

RoHS 2011/65/EU incl. 2015/863/EU	✓
POP regulation (EU) 2019/1021	✓

Regulations and Standards

Norm	DIN EN IEC 60309-2
Declaration of Conformity	CE
Test label	VDE, EAC, CQC

Dimensional Drawing

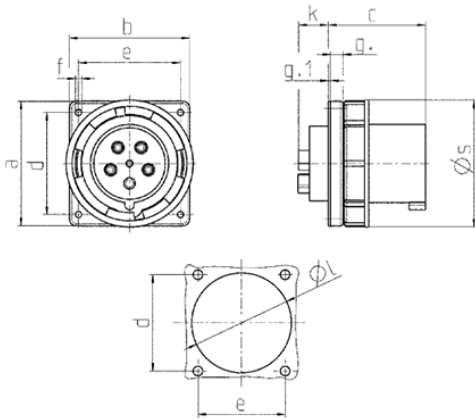

Drawing	Amp. Poles	63			125		
		3	4	5	3	4	5
2 MB 166							
Dim. in mm	a	110	110	110	130	130	130
	b	106	106	106	130	130	130
	c	86	86	86	112	112	112
	d	90	90	90	104	104	104
	e	90	90	90	104	104	104
	f	5.5	5.5	5.5	6.5	6.5	6.5
	g.	12	12	12	18	18	18
	g.1	2	2	2	2	2	2
	k	28	28	28	28	28	28
	l	88.5	88.5	88.5	95	95	95
	s	113	113	113	132	132	132
Terminal for cond. cross section (mm ²) min.-max.		6	6	6	25	25	25
		-16	-16	-16	-70	-70	-70