

Panel mounted receptacle

Part number: 3114



MENNEKES
Elektrotechnik GmbH & Co. KG

Aloys-Mennekes-Straße 1
57399 Kirchhundem
GERMANY

Product Description

- screw connection technology
- 20° inclination
- receptacle is designed for adding an auxiliary contact switch

Technical Details

Panel mounted receptacle	3114
Ampere	32A
Number of poles	4p
Clock position	7h
Nominal voltage AC	500V
Nominal frequency	50 - 60 Hz
Protection type IP	IP44
Contact carrier	standard
X-CONTACT	no
Connection	screw terminals
Contact screw drive	PZ2, slot
Pilot contact	without pilot contact
Pilot contact switch	no
Flange dimensions	85 x 85 mm
Hole spacings	70 x 70 mm
Insertion direction	angled
Inclination	20°
Highly resistant to chemicals	no
Military version	no
Tightening torque connection terminal for cable cross-section 1,0 - 1,5 mm ²	0.6 Nm
Tightening torque connection terminal for cable cross-section 2,5 - 4,0 mm ²	0.8 Nm
Tightening torque connection terminal for cable cross-section 6 - 10 mm ²	1.2 Nm
Strip length PH + N flexible conductor	12 - 17 mm
Strip length PE flexible conductor	12 - 17 mm
Strip length PH + N solid conductor	12 - 17 mm

Panel mounted receptacle	3114
Strip length PE solid conductor	12 - 17 mm
Conductor cross-section min.	2.5 mm ²
Conductor cross-section max.	10 mm ²
Weight (net)	240 g
Packaging unit	10 pcs
Quantity per pallet	660 pcs
EAN / identification number	4015394209638

Permissible ambient conditions

	Min.	Max.
Permissible ambient temperature	-25 °C	40 °C
Average temperature over 24 hours		35 °C

Material properties

Housing	PA6 light grey [similar RAL 7035]
Hinged lid	PC black [similar RAL 9005]

Material resistance

The material resistance overview can be found on the website in the section “Knowledge” - “Product knowledge” - “Materials”.

Material and environmental properties

RoHS 2011/65/EU incl. 2015/863/EU	✓
POP regulation (EU) 2019/1021	✓
Halogen-free	yes

Regulations and Standards

Norm	DIN EN IEC 60309-2
Declaration of Conformity	CE
Test label	EAC

Dimensional Drawing

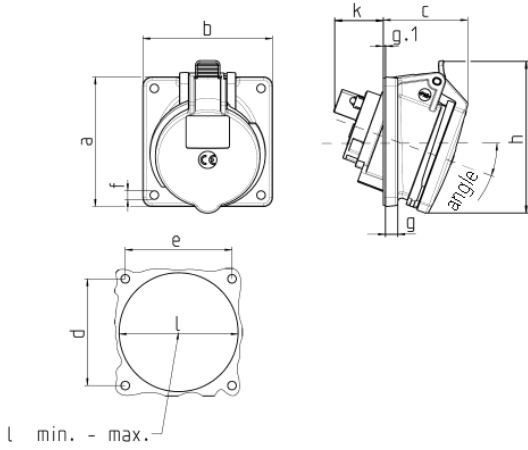

Drawing	Amp.	16			32		
		Poles			3	4	5
1 MB 453							
Dim. in mm	a	85	85	85	85	85	85
	b	85	85	85	85	85	85
	c	53	57	57	60	60	67
	d	70	70	70	70	70	70
	e	70	70	70	70	70	70
	f	5.5	5.5	5.5	5.5	5.5	5.5
	g	8	8	8	8	8	8
	g.1	2	2	2	2	2	2
	h	89	96	101	103	103	110
	k	39	34	33	53	53	41
	l min.	57	64	70	78	78	78
	l max.	78	78	78	78	78	78
Terminal for cond. cross section (mm ²) min.-max.		1.5	1.5	1.5	2.5	2.5	2.5
		-4	-4	-4	-10	-10	-10