

Panel mounted receptacle

Part number: 230A



MENNEKES
Elektrotechnik GmbH & Co. KG

Aloys-Mennekes-Straße 1
57399 Kirchhundem
GERMANY

Product Description

- screw connection technology
- straight insertion direction

Technical Details

Panel mounted receptacle	230A
Ampere	32A
Number of poles	3p
Clock position	6h
Nominal voltage AC	230V
Nominal frequency	50 - 60 Hz
Protection type IP	IP67
Contact carrier	standard
X-CONTACT	no
Connection	screw terminals
Contact screw drive	PZ2, slot
Pilot contact	without pilot contact
Pilot contact switch	no
Flange dimensions	85 x 75 mm
Hole spacings	60 x 60 mm
Insertion direction	straight
Highly resistant to chemicals	no
Military version	no
Tightening torque connection terminal for cable cross-section 1,0 - 1,5 mm ²	0.6 Nm
Tightening torque connection terminal for cable cross-section 2,5 - 4,0 mm ²	0.8 Nm
Tightening torque connection terminal for cable cross-section 6 - 10 mm ²	1.2 Nm
Strip length PH + N flexible conductor	12 - 17 mm
Strip length PE flexible conductor	12 - 17 mm
Strip length PH + N solid conductor	12 - 17 mm
Strip length PE solid conductor	12 - 17 mm

Panel mounted receptacle	230A
Conductor cross-section min.	2.5 mm ²
Conductor cross-section max.	10 mm ²
Weight (net)	266 g
Packaging unit	10 pcs
Quantity per pallet	660 pcs
EAN / identification number	4015394001249

Permissible ambient conditions		
	Min.	Max.
Permissible ambient temperature	-25 °C	40 °C
Average temperature over 24 hours		35 °C

Material properties	
Housing	PA6 light grey [similar RAL 7035]
Hinged lid	PA6 blue [similar RAL 5007] TPE black [similar RAL 9005] PBT/PC squirrel grey [similar RAL 7000]

Material resistance

The material resistance overview can be found on the website in the section “Knowledge” - “Product knowledge” - “Materials”.

Material and environmental properties	
RoHS 2011/65/EU incl. 2015/863/EU	✓
POP regulation (EU) 2019/1021	✓
Halogen-free	yes

Regulations and Standards

Norm	DIN EN IEC 60309-2
Declaration of Conformity	CE
Test label	CB Zertifikat, VDE, EAC, CQC

Dimensional Drawing

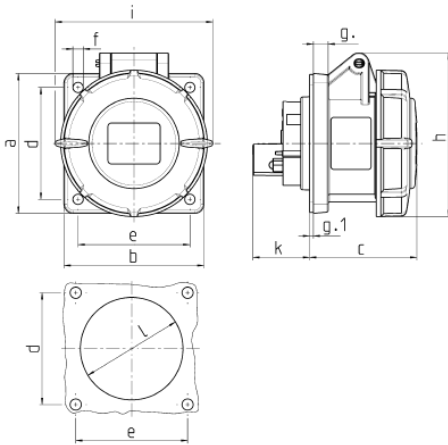

Drawing	Amp.	16			32		
		3	4	5	3	4	5
1 MB 141	Poles						
Dim. in mm	a	75	75	75	85	85	85
	b	75	75	75	75	75	75
	c	60	61	61	70	70	72
	d	60	60	60	60	60	60
	e	60	60	60	60	60	60
	f	5.5	5.5	5.5	5.5	5.5	5.5
	g.	8	8	8	8	8	8
	g.1	2	2	2	2	2	2
	h	83	88	95	99	99	105
	i	78	85	96	103	103	110
	k	31	32	32	39	39	39
	l	43	52	54	58	58	65
	Terminal for cond. cross section (mm²) min.-max.	1.5	1.5	1.5	2.5	2.5	2.5
		-4	-4	-4	-10	-10	-10