

Panel mounted receptacle

Part number: 1393



MENNEKES
Elektrotechnik GmbH & Co. KG

Aloys-Mennekes-Straße 1
57399 Kirchhundem
GERMANY

Product Description

- screw connection technology
- straight insertion direction

Technical Details

Panel mounted receptacle	1393
Ampere	16A
Number of poles	4p
Clock position	2h
Nominal voltage AC	50 - 500V
Nominal frequency	300 - 500 Hz
Protection type IP	IP44
Contact carrier	standard
X-CONTACT	no
Connection	screw terminals
Contact screw drive	PZ2, slot
Pilot contact	without pilot contact
Pilot contact switch	no
Flange dimensions	75 x 75 mm
Hole spacings	60 x 60 mm
Insertion direction	straight
Highly resistant to chemicals	no
Military version	no
Tightening torque connection terminal for cable cross-section 1,0 - 1,5 mm ²	0.6 Nm
Tightening torque connection terminal for cable cross-section 2,5 - 4,0 mm ²	0.8 Nm
Tightening torque connection terminal for cable cross-section 6 - 10 mm ²	1.2 Nm
Strip length PH + N flexible conductor	8 - 10 mm
Strip length PE flexible conductor	12 - 17 mm
Strip length PH + N solid conductor	8 - 10 mm
Strip length PE solid conductor	12 - 17 mm

Panel mounted receptacle	1393
Conductor cross-section min.	1.5 mm ²
Conductor cross-section max.	4 mm ²
Weight (net)	161 g
Packaging unit	10 pcs
Quantity per pallet	1520 pcs
EAN / identification number	4015394010265

Permissible ambient conditions		
	Min.	Max.
Permissible ambient temperature	-25 °C	40 °C
Average temperature over 24 hours		35 °C

Material properties	
Housing	PA6 light grey [similar RAL 7035]
Hinged lid	PA6 green [similar RAL 6010]

Material resistance

The material resistance overview can be found on the website in the section “Knowledge” - “Product knowledge” - “Materials”.

Material and environmental properties	
RoHS 2011/65/EU incl. 2015/863/EU	✓
POP regulation (EU) 2019/1021	✓
Halogen-free	no

Regulations and Standards

Norm	DIN EN IEC 60309-2
Declaration of Conformity	CE
Test label	EAC, CQC

Dimensional Drawing

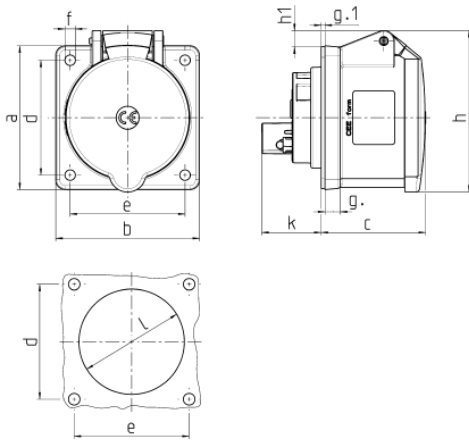

Drawing 1 MB 247	Amp. Poles	16			32		
		3	4	5	3	4	5
Dim. in mm	a	75	75	75	75	75	75
	b	75	75	75	75	75	75
	c	53	53	55	64	64	65
	d	60	60	60	60	60	60
	e	60	60	60	60	60	60
	f	5.5	5.5	5.5	5.5	5.5	5.5
	g.	8	8	8	8	8	8
	g.1	2	2	2	2	2	2
	h	75	80	83	89	89	100
	h1		6	8	11	11	12
	k	31	32	32	39	39	39
	l	43	52	54	58	58	62
Terminal for cond. cross section (mm ²) min.-max.		1.5 —4	1.5 —4	1.5 —4	2.5 —10	2.5 —10	2.5 —10