

Panel mounted receptacle

Part number: 1155A



MENNEKES
Elektrotechnik GmbH & Co. KG

Aloys-Mennekes-Straße 1
57399 Kirchhundem
GERMANY

Product Description

- frame terminals
- X-CONTACT
- 20° inclination

Technical Details

Panel mounted receptacle	1155A
Ampere	63A
Number of poles	5p
Clock position	6h
Nominal voltage AC	400V
Nominal frequency	50 - 60 Hz
Protection type IP	IP44
Contact carrier	standard
X-CONTACT	yes
Connection	frame terminals
Contact screw drive	PZ2, slot
Pilot contact	without pilot contact
Pilot contact switch	no
Flange dimensions	110 x 106 mm
Hole spacings	85 x 77 mm
Insertion direction	angled
Inclination	20°
Highly resistant to chemicals	no
Military version	no
Tightening torque connection terminal	2 Nm
Conductor cross-section min.	6 mm ²
Conductor cross-section max.	25 mm ²
Weight (net)	627 g
Packaging unit	5 pcs
Quantity per pallet	330 pcs

Panel mounted receptacle	1155A
EAN / identification number	4015394007890

Permissible ambient conditions		
	Min.	Max.
Permissible ambient temperature	-25 °C	40 °C
Average temperature over 24 hours		35 °C

Material properties	
Housing	PC light grey [similar RAL 7035]
Hinged lid	PC red [similar RAL 3013]

Material resistance

The material resistance overview can be found on the website in the section “Knowledge” - “Product knowledge” - “Materials”.

Material and environmental properties	
RoHS 2011/65/EU incl. 2015/863/EU	✓
POP regulation (EU) 2019/1021	✓
Halogen-free	no

Regulations and Standards	
Norm	DIN EN IEC 60309-2
Declaration of Conformity	CE
Test label	CB Zertifikat, VDE, EAC, CQC

Dimensional Drawing

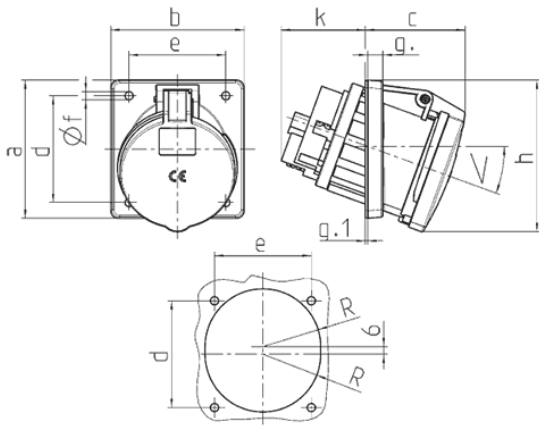

Drawing 1 MB 297	Amp. Poles	63		
		3	4	5
Dim. in mm	a	110	110	110
	b	106	106	106
	c	82	82	82
	d	85	85	85
	e	77	77	77
	f	6.5	6.5	6.5
	g.	12	12	12
	g.1	2	2	2
	h	122	122	122
	k	69	69	69
	R	46	46	46
	α	20°	20°	20°
Terminal for cond. cross section (mm ²) min.-max.		6 —25	6 —25	6 —25