

Wall mounted receptacle

Part number: 1145A



MENNEKES
Elektrotechnik GmbH & Co. KG

Aloys-Mennekes-Straße 1
57399 Kirchhundem
GERMANY

Product Description

- frame terminals
- X-CONTACT
- internal fixing
- 25° inclination
- enclosure can be turned 180°
- with 6 fixing points to accommodate special terminals

Technical Details

Wall mounted receptacle	1145A
Ampere	63A
Number of poles	5p
Clock position	6h
Nominal voltage AC	400V
Nominal frequency	50 - 60 Hz
Protection type IP	IP44
Contact carrier	standard
X-CONTACT	yes
Connection	frame terminals
Contact screw drive	PZ2, slot
Screw drive external screws	PZ2, slot
Pilot contact	without pilot contact
Pilot contact switch	no
Cable entry at the top	1 x M40
Cable entry at the bottom	2 x M40 (blind)
Blind cable entry at the rear	no
Enclosure base can be turned 180°	yes
Insertion direction	angled
Inclination	25°
Type of mounting	internal fixing
Highly resistant to chemicals	no
Military version	no
Lockable	no
Tightening torque connection terminal	2 Nm

Wall mounted receptacle	1145A
Conductor cross-section min.	6 mm ²
Conductor cross-section max.	25 mm ²
Weight (net)	958 g
Packaging unit	5 pcs
Quantity per pallet	160 pcs
EAN / identification number	4015394007708

Permissible ambient conditions		
	Min.	Max.
Permissible ambient temperature	-25 °C	40 °C
Average temperature over 24 hours		35 °C

Material properties	
Base	PC/PET light grey [similar RAL 7035]
Upper part	PC/PET light grey [similar RAL 7035]
Hinged lid	PC red [similar RAL 3013]
External screws	stainless steel bare

Material resistance

The material resistance overview can be found on the website in the section “Knowledge” - “Product knowledge” - “Materials”.

Material and environmental properties	
RoHS 2011/65/EU incl. 2015/863/EU	✓
POP regulation (EU) 2019/1021	✓
Halogen-free	no

Regulations and Standards

Norm	DIN EN IEC 60309-2
Declaration of Conformity	CE
Test label	CB Zertifikat, VDE, EAC, CQC

Dimensional Drawing

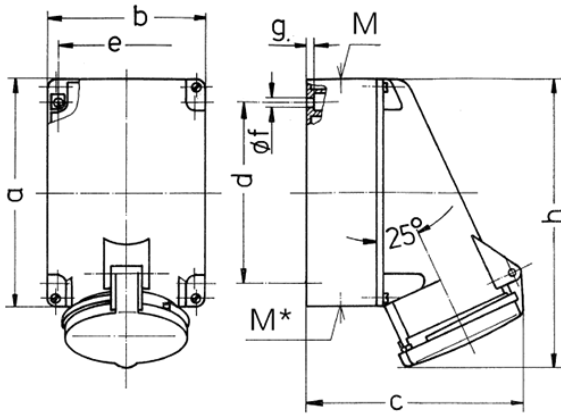

Drawing 1 MB 213	Amp. Poles	63		
		3	4	5
Dim. in mm	a	170	170	170
	b	118	118	118
	c	164	164	164
	d	134.5	134.5	134.5
	e	103	103	103
	f	6.1	6.1	6.1
	g	6	6	6
	h	216	216	216
	M	40	40	40
	M*	2xM40 (blind) to be cut out		
	Max. cable diam. (mm)	32	32	32
	Terminal for cond. cross section (mm ²) min.-max.	6	6	6
		-25	-25	-25